

GV-EDR2100 Series 2MP H.264 Low Lux WDR IR Mini Fixed Rugged IP Dome



- 1/2.8" progressive scan low lux CMOS
- Dual streams from H.264 and MJPEG
- Up to 30 fps at 1920 x 1080
- Intelligent IR
- Day and Night function (with removable IR-cut filter)
- Vandal resistance (IK10 for metal casing)
- Ingress protection (IP67)
- 2-axis mechanism (pan / tilt)
- Wide Dynamic Range (WDR)
- Defog
- Motion detection
- Tampering alarm
- Text overlay
- Privacy mask
- IP address filtering
- DC 12V / PoE (IEEE 802.3af)
- Megapixel lens
- Recording assigned by GV-Edge Recording Manager (Windows & Mac)
- Supports iPhone, iPad, Android & 3GPP
- 31 languages on Web interface
- ONVIF (Profile S) conformant
- More Storage Option - NAS

Introduction

The Target Mini Fixed Rugged Dome is an outdoor, fixed, mini-sized network camera equipped with an automatic IR-cut filter and IR LEDs for day and night surveillance. The camera adheres to IK10 and IP67 standards. It is adjustable in 2 axis (pan and tilt) and can be connected through PoE.

Models

Model	Iris	Focal Length (mm)	Maximum Aperture	Image Format
GV-EDR2100-0F	Fixed	2.8	F/2.0	1/2.7"
GV-EDR2100-2F	Fixed	3.8	F/1.8	1/2.7"

Active Tampering Alarm

Tampered



Focus Change



Camera Shift

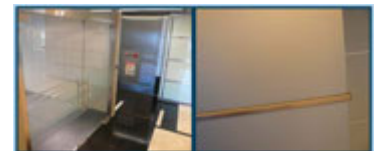

Dimensions

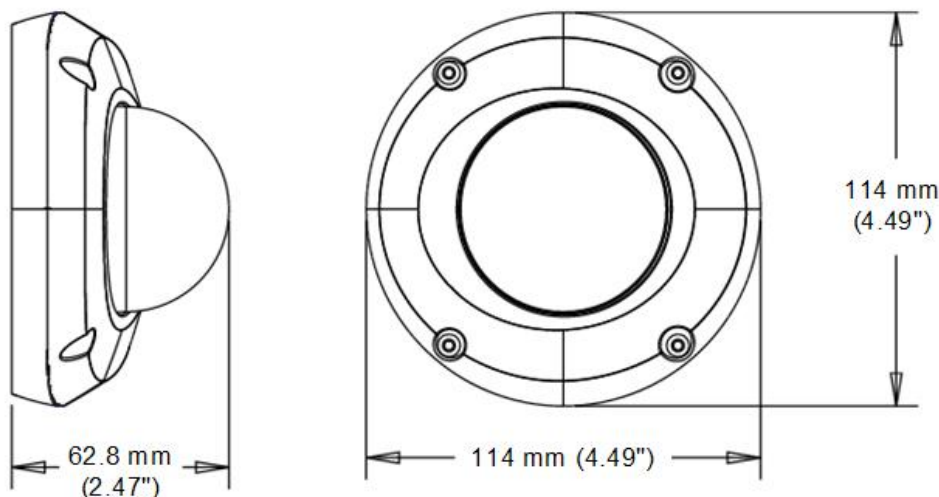

Specifications

Camera		GV-EDR2100-0F	GV-EDR2100-2F
Image Sensor		1/2.8" progressive scan low lux CMOS	
Picture Elements		1920 (H) x 1080 (V)	
Minimum Illumination	Color	0.07 Lux	
	B/W	0.04 Lux	
	IR ON	0 Lux	
Shutter Speed		Automatic, manual (1/5 ~ 1/8000 sec.)	
White Balance		Automatic, manual (2800K ~ 8500K)	
Gain Control		Automatic	
S/N Ratio		48 dB	
WDR		Yes	
Dynamic Range		Up to 72 dB	
Lens			
Megapixel		Yes	
Day/Night		Yes (with removable IR-cut filter)	
Focal Length		2.8 mm	3.8 mm
Lens Type		Fixed	
Maximum Aperture		F/2.0	F/1.8
Mount		M12, Pitch 0.5 mm	
Horizontal FOV		99°	72°
Image Format		1/2.7"	
Operation	Focus	Fixed	
	Zoom	Fixed	
	Iris	Fixed	
IR LED Quantity		12 IR LEDs	
Max. IR Distance		15 m (50 ft)	
Operation			
Video Compression		H.264, MJPEG	
Video Streaming		Dual streams from H.264 and MJPEG	
Frame Rate		30 fps at 1920 x 1080 (60/50 Hz) * The frame rate and the performance may vary depending on the number of connections and data bitrates (different scenes).	
Image Setting		Brightness, Contrast, Saturation, Sharpness, Gamma, White Balance, Flicker-less, Image Orientation, Shutter Speed, D/N Sensitivity, Backlight Compensation, WDR, Defog	
Audio Support		N/A	

Video Resolution		
Main Stream	4:3	1280 x 960, 640 x 480, 320 x 240
	16:9	1920 x 1080 (Default), 1280 x 720, 640 x 360, 448 x 252
	5:4	1280 x 1024, 640 x 512, 320 x 256
Sub Stream	4:3	640 x 480, 320 x 240
	16:9	640 x 360, 448 x 252 (Default)
	5:4	640 x 512, 320 x 256
Network		
Interface	10/100 Ethernet	
Ethernet Protocol	DHCP, DynDNS, FTP, HTTP, HTTPS, NTP, ONVIF (Profile S), QoS (DSCP), RTSP, SNMP, SMTP, TCP, UDP, UPnP, 3GPP/ISMA, IPv4, IPv6	
Mechanical		
Camera Angle Adjustment	Pan	-45° ~ 45°
	Tilt	0° ~ 63°
Connectors	Power	2-pin terminal block, PoE
	Ethernet	Ethernet (10/100 Base-T), RJ-45 cable
LED Indicator	4 LEDs: Link, ACT, Power, Status	
General		
Environment Temperature	Start-up	-20°C ~ 50°C (-4°F ~ 122°F)
	Operation	-30°C ~ 50°C (-22°F ~ 122°F)
Humidity	10% to 90% (no condensation)	
Power Source	12V DC / PoE (IEEE 802.3af)	
Max. Power Consumption	5.8 W	
Dimension	ø 114 x 62.8 mm (4.49" x 2.47")	
Weight	600 g (1.32 lb)	
Ingress Protection	IP67	
Vandal Resistance	IK10 for metal casing	
Regulatory	CE, FCC, RCM, RoHS compliant	
Power over Ethernet		
PoE Standard	PoE (IEEE 802.3af Power over Ethernet / PD)	
PoE Power Supply Type	End-span	
PoE Power Output	Per Port 48V DC, 350 mA, Max. 15.4 watts	
Web Interface		
Installation Management	Web-based configuration	
Maintenance	Firmware upgrade through Web Browser or Utility	
Access from Web Browser	Camera Live View, Video Recording, Change Video Quality, Bandwidth Control, Image Snapshot, Audio, Picture in Picture, Picture and Picture, Privacy Mask, Text Overlay, Digital PTZ	
Language	Arabic / Bulgarian / Czech / Danish / Dutch / English / Finnish / French / German / Greek / Hebrew / Hungarian / Indonesian / Italian / Japanese / Lithuanian / Norwegian / Persian / Polish / Portuguese / Romanian / Russian / Serbian / Simplified Chinese / Slovakian / Slovenian / Spanish / Swedish / Thai / Traditional Chinese / Turkish	
Applications		
Network Storage	GV-System (GV-DVR/NVR), GV-Recording Server, GV-VMS	
Smart Device Access	GV-Eye for iOS and Android	
Live Viewing	IE, Mobile App	
CMS Server support	GV-Control Center, GV-Center V2, GV-Vital Sign Monitor	



Note: Specifications are subject to change without prior notice.



Packing List

- | | |
|-----------------------------------------------------------------------------|------------------------------------------|
| 1. Target Mini Fixed Rugged Dome | 9. Torx Wrench |
| 2. Screw x 2 | 10. Silica Gel Bag x 2 |
| 3. Screw Anchor x 2 | 11. Adhesive Tape for Silica Gel Bag x 2 |
| 4. Focus Adjustment Ring | 12. Concave hexagon Wrench |
| 5. Installation Sticker | 13. Ruler |
| 6. Conduit Converter | 14. Screw for Conduit Converter x 2 |
| 7. RJ-45 Connector | 15. GV-IPCAM H.264 Software DVD |
| 8. Waterproof rubber sets
(for RJ-45 Cat.5 and 12V DC / for RJ-45 Cat.6) | 16. GV-NVR Software DVD |
| | 17. Warranty Card |

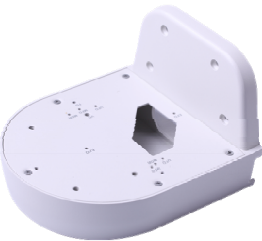
Note: Power adapters can be purchased upon request.

Accessories

Model No./Name	Details
GV-Mount900 Wall Mount Bracket 	Dimensions: 154 x 108 x 50 mm (6.1" x 4.3" x 2") Weight: 240 g (0.53 lb)
GV-Mount909 Wall Mount Bracket 	Dimensions: 170 x 150 x 110 mm (6.7" x 5.9" x 4.3") Weight: 610 g (1.34 lb)
GV-Mount910 Power Box Mount Bracket 	Dimensions: 112 x 98 x 7.5 mm (4.4" x 3.9" x 0.3") Weight: 105 g (0.23 lb)
GV-Mount913 Power Box Mount Bracket 	Dimensions: Ø 146 x 7.5 mm (Ø 5.7" x 0.3") Weight: 180 g (0.4 lb)

Model No./Name	Details
GV-Mount918 Wall Mount Bracket for MFD/MDR/efd/EDR	Dimensions: Ø 145 x 117 x 96 mm (Ø 5.71 x 4.60 x 3.78") Weight: 350 g (0.77 lb)
	
GV-PA191 PoE Adapter	Dimensions (H x W x D): 43 x 69 x 40 mm (1.69" x 2.72" x 1.57") Weight: 130 g (0.29 lb)
	
Plastic PG21 Conduit Connector	The plastic PG21 conduit connector is used for running the wires of the camera through a 1/2" conduit pipe.
	
Power Adapter	Contact your sales representative for the countries and areas supported.
GV-POE Switch	The GV-POE Switch is designed to provide power along with network connection for IP devices. The GV-POE Switch is available in various models with different numbers and types of ports.

www.avsupply.com