

Amazon2

700 Series



Overview

The Amazon2 700 Series is a new group of industrial digital cameras that are compliant with both the Gigabit Ethernet and with the GigE Vision standards. They provide high quality performance with various resolutions and frame rates; all at very competitive pricing. A list of outstanding features provide excellent flexibility for the user! The small housing (29mm(W) x 29mm(H) x 51mm(D) and 58 g) will fit most industrial camera applications. Select one of our new GigE Vision Amazon2 700 Series cameras and make your industrial vision project more successful and efficient.

Dimension

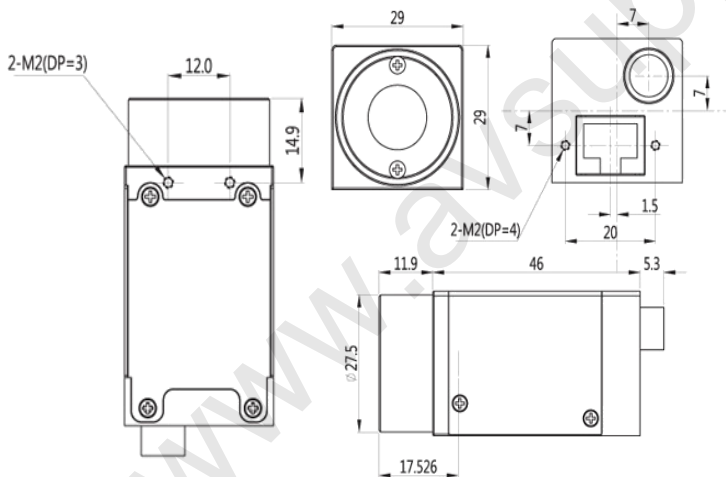

Accessories

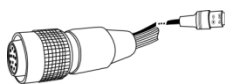

Trigger/Power Cable

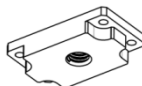

Tripod Plate



imi tech

For design help, accessories or pricing, please contact
sales@avsupply or call: 1-858-565-1101

AUDIOVIDEO SUPPLY

1-800-284-2288 sales@avsupply.com
www.avsupply.com

Specifications

Model	IMx-716G	IMC-715G2	IMx-715G	IMx-712G	IMx-711G	IMx-710G
Image Sensor	1/3" Sony CCD	1/3" Sony CCD	1/3" Sony CCD	1/2" Sony CCD	1/3" Sony CCD	1/4" Sony CCD
Sensor Name	ICX445 AL/AQ	ICX692 AQ	ICX204 AL/AK	ICX414 AL/AQ	ICX424 AL/AQ	ICX618 AL/AQ
Resolution	Megapixel	1.3MP	0.9MP	0.78MP	0.3MP	0.3MP
	HxV	1288 x 964	1280 x 720	1032 x 776	656 x 484	656 x 488
Pixel Size	3.75µm x 3.75µm	4.08µm x 4.08µm	4.65µm x 4.65µm	9.90µm x 9.90µm	7.40µm x 7.40µm	5.60µm x 5.60µm
Frame Rate	30 fps	30 fps	36 fps	90 fps	90 fps	100 fps

Model	IMC-770GC	IMx-750GC	IMx-720G	IMx-717
Image Sensor	1/2.3" Aptina CMOS	1/2.5" Aptina CMOS	1/1.8" Sony CCD	1/2" Sony CCD
Sensor Name	MT9J003	MT9P031	ICX274 AL/AQ	ICX267 AL/AK
Resolution	Megapixel	10MP	5.0MP	2.0MP
	HxV	3660 x 2744	2588 x 1940	1624 x 1232
Pixel Size	1.67µm x 1.67µm	2.20µm x 2.20µm	4.40µm x 4.40µm	4.65µm x 4.65µm
Frame Rate	7.3 fps	14 fps	25 or 16 fps	30 fps

Common Specifications

Digital Interface	Gigabit Ethernet
Transfer Rate	1000 Mbps
Scanning System	Progressive Scan
Shutter Type	Global Shutter (IMC-770GC / IMC-750GC: Rolling Shutter)
Data Path	8 or 12 bit B/W (YUV 4:2:2 / YUV 4:1:1)
Binning	2x2 (Mono only) * Color/Mono is available for IMx-720G
ROI	Partial Scan (Unit:4x4)
Trigger	External or Software Trigger with various mode (IMC-770GC / IMC-750GC only S/W trigger)
I/O Port	Ext. Trigger, RS232, Strobe (6-pin)
Memory Save/Load	9 Channels (0:factory, 1~4:feature, 5~8:mode/feature)
SIO(RS-232)	Pass through or IMI-Tech Command
Gain Control	0 ~ 18 dB (Manual or Auto)
Shutter Speed	1 µsec ~ 3600 sec
Control Functions	Brightness, Sharpness, Gamma, Auto-gain, Auto-Exposure, Auto-Shutter, (Saturation, Auto White Balance, Hue)
Lens Mount	C/CS Mount
Operating Temp.	-5°C ~ 45°C
Storage Temp.	-30°C ~ 60°C
Supply Voltage	DC 8V ~ DC 30V / PoE
Power Consumption	Max. 2.7W@12VDC, Max. 2.5W@PoE 802.3af (IMx-720G / IMx-717G: Max. 3.0W@12VDC, Max. 3.2W@PoE 802.3af)
Dimension	29(W)x29(H)x51.1(D)mm(without Lens Adapter)
Weight	< 58g

* All specifications are subject to change without notice.



For design help, accessories or pricing, please contact:
sales@avsupply or call: 1-858-565-1101

Spectral Sensitivity

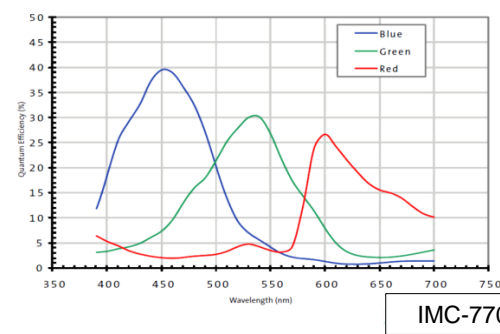
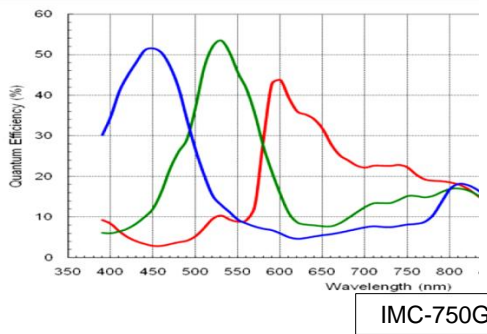
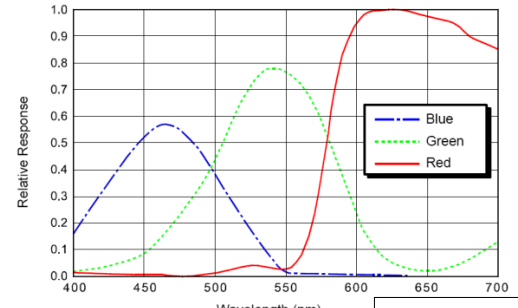
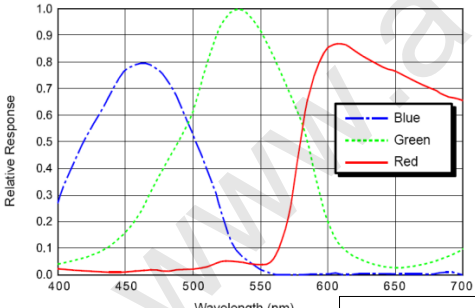
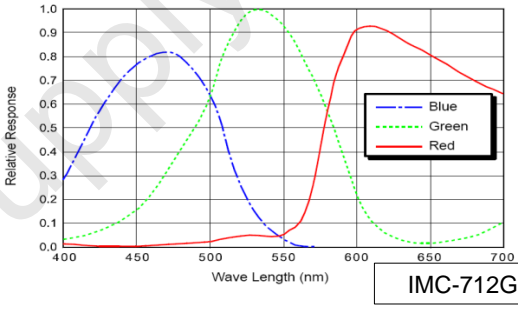
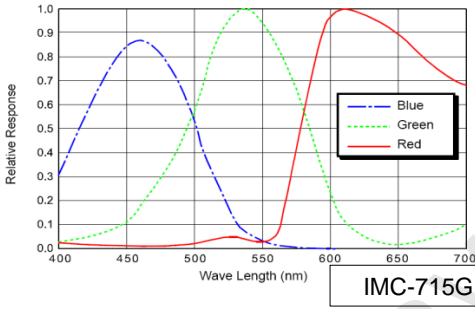
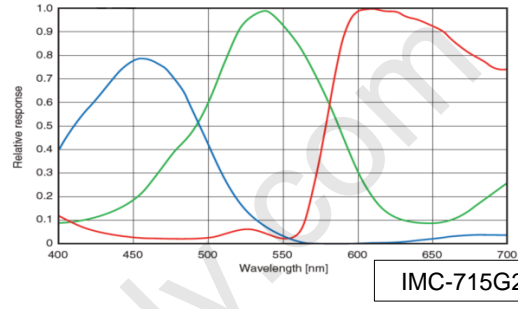
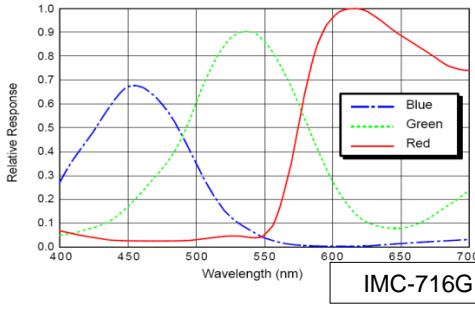
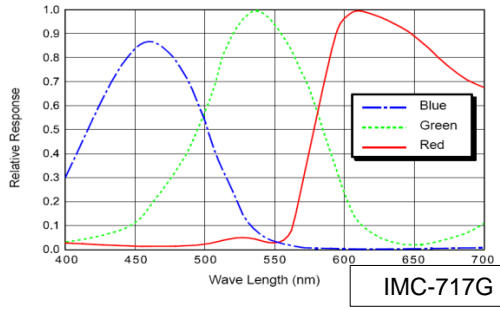
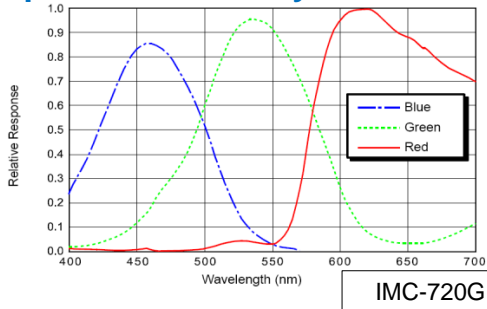

For design help, accessories or pricing, please contact:
 sales@avsupply or call: 1-858-565-1101

Spectral Sensitivity

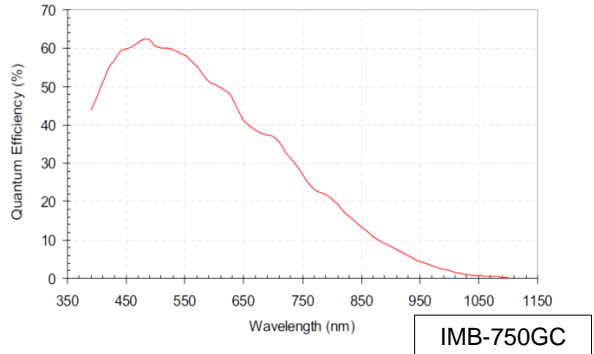
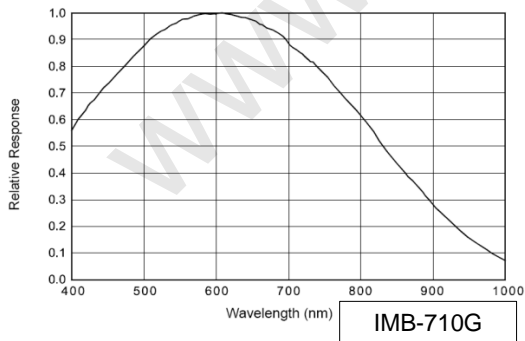
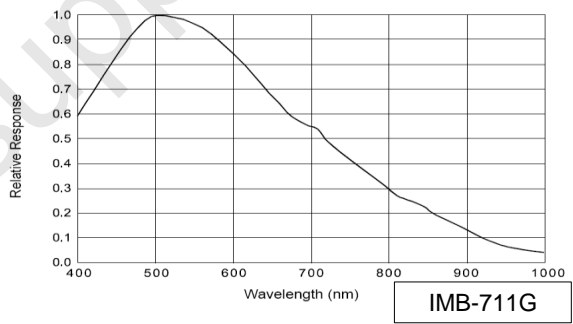
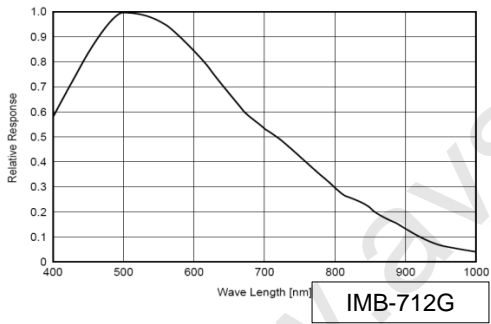
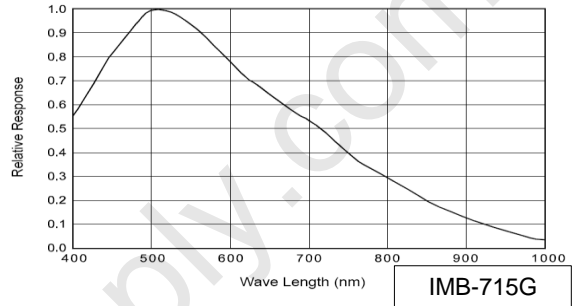
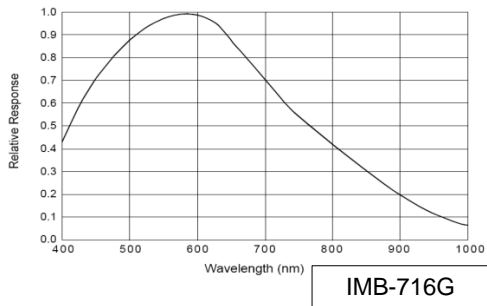
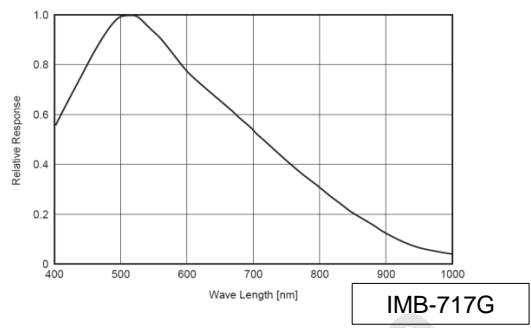
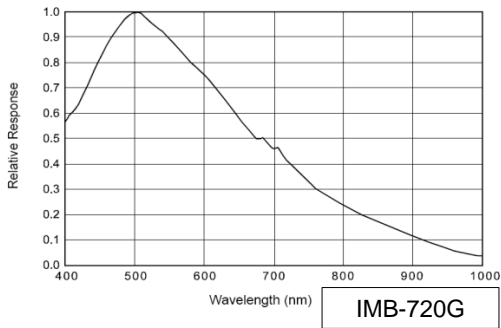

#616, Mega Valley, 799, Gwangyang 2-dong, Dongan-gu, Anyang-city, Gyeonggi-do, Korea
 TEL +82 31 423 9801, +82 70 4361 4516~8(Oversea) Fax +82 31 423 9803
 E-mail: world@imi-tech.com Homepage: www.imi-tech.com



For design help, accessories or pricing, please contact:
 sales@avsupply or call: 1-858-565-1101